

Conserve Space with
Rodless Air Cylinders p26

Integrated Hydraulic System
is a Compact Package p36

The Internet of Things
For Industry p42

JOHN B. LARSON

Hydraulics & Pneumatics®

THE AUTHORITY ON FLUID POWER TECHNOLOGY
AND ITS CONTROL

JULY 2017 hydraulicspneumatics.com

HIGH TORQUE AND HIGH SPEED

Hydraulics
Lets You
Have It Both
Ways p22

\$10.00 Periodicals postage paid USPS 100 Approved Poly

Electrohydraulic
Pressure Control
P / 16

IN THIS ISSUE

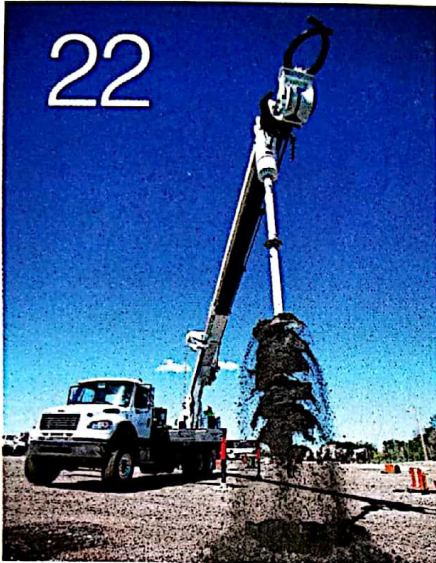

22

FEATURES

22 Hydraulics Power New Digger Derrick to Higher Levels
Heavy-duty digger derrick powers multiple functions with hydraulics and meets ANSI 10.31 specifications in a powerful, compact package.

26 Rodless Cylinders Handle It All
Whether you need to move a load up, down, in, or out, rodless cylinders provide an unconventional way to get it done.

31 Making the Connection with Pneumatic Couplings
Pneumatic quick-acting couplings provide a fast, convenient way to repeatedly connect and disconnect air lines.

36 Pumps & Motors: The Best of Both Worlds
A new electrohydrostatic drive concept can increase productivity and reduce energy consumption, while boasting simpler installation than existing drives.

39 Flush Out Contamination Problems
Fluid velocity during hydraulic-system flushing procedures is critical to successful removal of manufacturing and installation debris.

42 Bringing the Industrial Internet of Things to Fluid Power
Unlike the all-purpose IoT, the IIoT requires much more than just syncing your smartphone with individual devices.

DEPARTMENTS

| | | | |
|-----------|------------------------------------|-----------|----------------------------------|
| 4 | ON HYDRAULICSPNEUMATICS.COM | 16 | MOTION CONTROL |
| 8 | EDITOR'S PAGE | 44 | USEFUL PRODUCTS |
| 10 | INDUSTRY NEWS | 47 | ADVERTISERS INDEX |
| 12 | IDEAS & APPLICATIONS | 48 | TROUBLESHOOTING CHALLENGE |

ON THE COVER: Photo of Digger Derrick courtesy of Elliott Equipment Co.

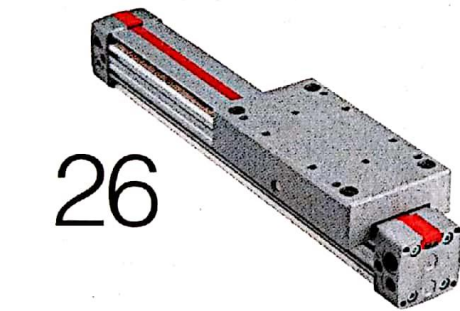

26

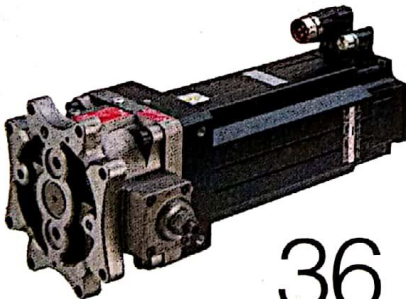

36

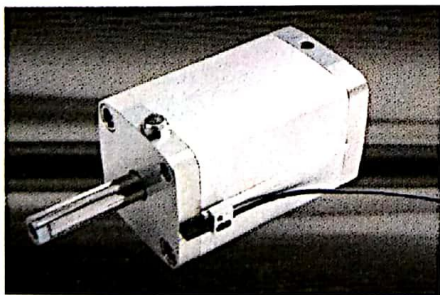

44



THE FPDA
MOTION & CONTROL NETWORK



JOIN US ONLINE



twitter.com/HPenton
facebook.com/HydraulicsPneumatics

ISSN 0018-814X
Printed in U.S.A. Copyright © 2017 by Penton Media, Inc., all rights reserved. *Hydraulics & Pneumatics* is published monthly by Penton Media, Inc., 9800 Metcalf Ave., Overland Park, KS 66212-2216. Phone: 216-696-7000. Periodicals postage paid at Kansas City, MO and at additional mailing offices. **POSTMASTER:** Send address changes to *Hydraulics & Pneumatics*, 1100 Avenue of the Americas, NY, NY 10036. Copying: permission is granted to users registered with the Copyright Clearance Center Inc. (CCC) to photocopy any article provided base fee of \$1.25 per copy of the article plus 60¢ per page is paid directly to CCC, 222 Rosewood Dr., Danvers, MA 01932 (Code No. 0018-814X/00 \$1.25 + 60¢).

Subscriptions — U.S. and possessions outside U.S.: \$70/yr; \$100 two yrs. Single copy: January \$15.00; all other issues \$8.00. In Canada: \$85.00/yr; \$135.00 two yrs. Canada Post Publications Mail Agreement No. 40612608. Canada return address: IMEX Global Solutions, PO box 25542, London, ON, N6C 6B2. International: \$100.00/yr; \$165.00 two yrs. To order, phone 847-763-9670. Fax orders to 847-763-9673. Send subscription payment to: *Hydraulics & Pneumatics*, P.O. Box 2100, Skokie, IL 60076-7800. Out-of-print copies available in complete volumes as positive microfilm from NAPCO 800-420-6272 x 6578. Photocopies of articles \$5.00 each. Payment must accompany request. Volume 70, No. 7, July 2017.

Looking for just
the right part,
at just the right price...

Connect with
over 200
distributors
on the NEW
SourceESB!



Find electronic parts fast -
from the only database
that verifies
part authorization.

Parts ▾ Enter part... Enter List 🔍



Part Lists Tool

- ✓ Send multi-part RFQs
- ✓ Save your part lists to work on later
- ✓ Filter by authorized distributor

www.SourceESB.com

Hydraulics & Pneumatics.

JULY 2017

EDITORIAL

EDITOR: **ALAN HITCHCOX** alan.hitchcox@penton.com
CONTENT PRODUCTION DIRECTOR: **MICHAEL BROWNE** michael.browne@penton.com
CONTENT PRODUCTION SPECIALIST: **ROGER ENGELKE** roger.engelke@penton.com
PRODUCTION EDITOR: **JEREMY COHEN** jeremy.cohen@penton.com
CONTENT OPTIMIZATION SPECIALIST: **WES SHOCKLEY** wes.shockley@penton.com
ASSOCIATE CONTENT PRODUCER: **LEAH SCULLY** leah.scully@penton.com
CONTRIBUTING EDITOR: **JACK L. JOHNSON** jack@idaseng.com
CONTRIBUTING EDITOR: **ROBERT J. SHEAF, JR.** rjsheaf@cfc-solar.com

ART DEPARTMENT

GROUP DESIGN DIRECTOR: **ANTHONY VITOLO** tony.vitolo@penton.com
SENIOR ARTIST: **JIM MILLER** jim.miller@penton.com
CONTENT DESIGN SPECIALIST: **JOCELYN HARTZOG** jocelyn.hartzog@penton.com
CONTENT & DESIGN PRODUCTION MANAGER: **JULIE JANTZER-WARD** julie.jantzer-ward@penton.com

PRODUCTION

PRODUCTION MANAGER: **SUSAN POSKIN** susan.poskin@penton.com
GROUP PRODUCTION DIRECTOR: **CAREY SWEETEN** carey.sweeten@penton.com
PLEASE SEND INSERTION ORDERS TO: orders@penton.com

CIRCULATION LIST RENTALS & CUSTOMER SERVICE

USER MARKETING DIRECTOR: **BRENDA ROODE** brennda.roode@penton.com
USER MARKETING MANAGER: **DEBBIE BRADY** debbie.brady@penton.com
REPRINTS: **BRETT PETILLO** F | 877.652.5295 bpelillo@wrightsmedia.com

LIST RENTAL: SMARTREACH CLIENT SERVICES MANAGER:

JAMES ADDISON T | 212.204.4318 james.addison@penton.com

FREE SUBSCRIPTION/STATUS OF SUBSCRIPTION/ADDRESS CHANGE/MISSING BACK ISSUES:
OMEDA T | 847.513.6022 TOLL FREE | 866.505.7173

SALES REPRESENTATIVES

MANAGING DIRECTOR: **TRACY SMITH** T | 913.967.1324 F | 913.514.6881 tracy.smith@penton.com

NORTH AMERICA ACCOUNTS MANAGER: **RONALD KLIMKO** T | 216.931.9662 ronald.klimko@penton.com

INTERNATIONAL SALES

ITALY: **DIEGO CASIRAGHI** T | +011.390.31.261407 F | +011.390.31.261380 diego@casiraghi-adv.com

GERMANY, AUSTRIA, SWITZERLAND: **CHRISTIAN HOELSCHER** T | +011.49.89.95002778
christian.hoelscher@husonmedia.com

BELGIUM, NETHERLANDS, LUXEMBURG, UNITED KINGDOM, SCANDINAVIA, FRANCE, SPAIN, PORTUGAL:

RACHEL DISANTO T | +011.44.1625.876622 M | +011.44.7794.366887 rachel.disanto@husonmedia.com

PAN ASIA: **HELEN LAI** T | 866.2.2727.7799 F | 866.2.2728.3686 helen@twoway-com.com

ONLINE

MARKETING AUTOMATION SPECIALIST: **DAN KRAFT** dan.kraft@penton.com

PRODUCT DEVELOPMENT DIRECTOR: **RYAN MALEC** ryan.malec@penton.com

EMEDIA CLIENT SERVICE MANAGER: **JOANN MARTIN** joann.martin@penton.com

DESIGN ENGINEERING & SOURCING GROUP

EXECUTIVE DIRECTOR OF CONTENT AND USER ENGAGEMENT: **NANCY K. FRIEDRICH**

GROUP DIRECTOR OF OPERATIONS: **CHRISTINA CAVANO**

GROUP DIRECTOR OF MARKETING: **JANE COOPER**

PENTON

1166 AVENUE OF THE AMERICAS, 10TH FLOOR
NEW YORK, NY 10036 T | 212.204.4200

Electronic Design | Machine Design | Microwaves & RF | Source ESB | Hydraulics & Pneumatics |
Global Purchasing | Distribution Resource | Power Electronics | Defense Electronics

PENTON IS AN INFORMA BUSINESS

MAIN
MANUFACTURING PRODUCTS

'MAIN' HYDRAULIC FLANGES AND COMPONENTS



HYDRAULIC FLANGES AND COMPONENTS **New Catalog**

MAIN Manufacturing's Catalog includes the popular styles of an extensive offering of Hydraulic Flanges and Components – ready for immediate shipment. Dimensional drawings, part numbers, metric and weld specifications included. The "Quick Reference Guide" helps specify less popular items often stocked or quickly manufactured at our US plant.

MAIN Manufacturing Products, Inc.
Grand Blanc, MI
Phone: (800) 521-7918; FAX: (810) 953-1385
E-mail: info@mainmfg.com
Web: www.mainmfg.com

OVER 80 YEARS OF DEPENDABILITY
ISO 9001 & ISO 14001 Manufacturing Facility
A-List Flanges made in the USA

OVER FIVE BILLION DOLLAR INVENTORY
Flanges available in: B, G, N, S, V, W, and other configurations
Parts available in: Carbon Steel, 316, 304, 304L, 317 and others
MTR's available in: Stainless Steel and carbon Custom Steel flanges

TECHNICAL DRAWINGS PROVIDED
For all flanges, components and parts
Drawing standards: ASME, ANSI, ISO, DIN, JIS, BS, etc.
Drawing formats: PDF, DWG, DXF, etc.

HERCULES SEALING PRODUCTS
Quality Seals. Seal.



2016 SEAL CATALOG

The Hercules Seal Catalog contains over 800 pages of seals in the most popular styles and sizes. New styles for 2016 include the BHT and HT High Strength Seals, Super-Duty Rod Seals, Glass Filled and Nitrile Piston Seals, Multi-Piece Piston Seal Assemblies, Snap-In and Metal Clad Wipers, Graphite Wear Rings and Head Seals. This catalog's easy-to-use format lets you quickly locate u-seals, piston seals, scrapers, O-rings, piston rings, buffer seals and much more. Each listing includes seal material, temperature and pressure specifications along with cross-sectional drawings to simplify selection. To order a free copy of the Hercules 2016 Seal Catalog, visit the Hercules website at www.HerculesUS.com or call 866-625-0606.

Hercules Sealing Products
1016 North Belcher Road, Clearwater, Florida
Phone: 866-625-0606; Fax: 800-759-6391
Email: sales@herculesus.com

PENINSULAR CYLINDER CO.

Peninsular Cylinder Company
Manufacturer of hydraulic and pneumatic cylinders machined to NFPA and Metric standards.



Do you have specific application needs?
Contact us today:
sales@peninsularcylinders.com

S.A.E. Flanged Fluid Conducting Swivel Joints



4-Bolt Flanged Head & Flanged Port

Size: 1/2" thru 2-1/2"
Code 61 & Code 62

Technical drawings providing part numbers, operating units and dimensions for machine layout. One piece sub components with S.A.E. flanged connections provide reliable service for high horsepower fluid transmission.

Hydraulics Inc.
2935 Saint Louis Avenue Ft. Worth, Texas 76110
Phone: (817) 923.1965 FAX: (817) 927-8002
E-mail: info@hydraulicsinc.com
Web: www.hydraulicsinc.com

Advertisers Index

| | | | |
|--------------------------------|--------|-------------------------------------|---------|
| ACE CONTROLS..... | 17 | ICUEE..... | 23 |
| ACL SRL..... | 27 | KURT HYDRAULICS..... | 7 |
| ADSENS TECHNOLOGY..... | 33 | MAIN MFG. PRODUCTS..... | 33, 47 |
| AMETEK..... | 4 | MOCAP..... | 29 |
| AUTOMATION DIRECT..... | 5 | MP FILTRI..... | 46 |
| BECKWOOD PRESS..... | 29 | O'KEEFE CONTROLS INC..... | 25 |
| CERTAGS..... | 19 | PENINSULAR CYLINDER..... | 47 |
| CFC TRAINING INSTITUTE..... | 43 | ROTOR CLIP CO..... | 15 |
| DEMAC..... | 21 | SC HYDRAULICS ENGINEERING CORP..... | 30 |
| EURAL GNUTTI SPA..... | 37 | THE LEE COMPANY..... | 35 |
| FLUIDYNE FLUID POWER..... | 9 | TOMPKINS INDUSTRIES INC..... | IFC, 28 |
| FOR SPA..... | 30 | VELJAN HYDRAIR LTD..... | 1 |
| HAWE HYDRAULICS..... | IBC | VEST INC..... | 3 |
| HERCULES SEALING PRODUCTS..... | 47 | ZERO-MAX, INC..... | 14 |
| HYCOM INC..... | 32 | | |
| HYDRAULICS INC..... | 35, 47 | | |

Although every effort has been made to ensure the accuracy of this index, the publisher cannot be held responsible for any errors or omissions.